

LIFE™
Ionizers

| 7500

USER MANUAL





Contents

· Safety-----	04	· Installation Guide-----	17a
· Definition of ion water-----	09	· Installation Tips-----	17b
· Properties of Ionized Water-----	10	· Production of Ionized Water -----	18
· Installation of Parts Guide-----	11	· Alkaline, Acidic and Purified Water Usage Guide-----	19
· Operation Warnings-----	12	· Replacement of Filters and Installation Guide-----	20
· Operation Method-----	14	· Internal Filters Specs and Descriptions-----	21
· Indicator Functions-----	15	· Usage for Alkaline Ionized Water-----	22
· Voice Functions-----	16	· Usage for Acid Water-----	24
		· Common Problems and Solutions-----	26
		· Installation for Prefilter -----	28



Safety

Before carrying out any operation, it's important to read this instruction manual thoroughly so that your alkaline water ionizer is functioning at full capacity.





Some parts may be changed to increase product quality, function or for other reasons. In such a case, the manual may be inconsistent with the actual contents.

Pictures

We provide you with pictures to prevent any improper use of the machine and to prevent property damage.



 Warning	It may cause major damage to your body
 Caution	Mishandling may cause either financial damage or even physical damage
 Danger	Mishandling may cause mortality or serious injury

Indications

	To provide caution, warning and danger signs
	To provide information on general prohibitions
	To instruct users on general operation
	To ban opening the machine when it is likely to cause a source of injury such as electric shock
	To instruct users to disconnect power plug in case of a malfunction





Please read this thoroughly for your safety.

	Mind the following when you drink alkaline water 1. Do not take drugs or medications with alkaline water. They should be taken only with purified water. 2. If you are suffering from achlorhydria (no stomach acid), do not drink the alkaline water.
	Do not use undrinkable water (ground water, dirty water) this may cause sickness or death.



Please read this thoroughly for your safety.

	The machine shouldn't be disassembled or repaired by an unauthorized person or it may cause an electrical fire. The manufacturer is not responsible for this.
	The machine shouldn't be placed in a humid area such as a bathroom. Do not clean by spraying the ionizer with water, as this can cause an electric shock.



Please read this thoroughly for your safety.



Please read this thoroughly for your safety.

	Power plug should not be touched or operated with wet hands and should be unplugged before any operation.
	Please follow these instructions when the machine, by error, has fallen into water or it may cause a source of electric shock. 1. Unplug power plug from an outlet 2. Take the machine out of the water 3. Contact your distributor
	Use only required voltage
	Make sure the power cord has not been crimped since it may cause an electrical fire. Water distribution hose should not be placed higher than the main machine or it may cause a malfunction.
	Power cord should not be stapled as stapling may damage power cord this may cause a fire or electric shock.
	Do not connect multiple electric appliances with a single power receptacle.
	When an outlet has been covered with dust, it must be cleaned before putting the power plug in or it can cause electrical problems.
	Do not damage power cord by, bending, pulling, twisting or putting heavy objects on top of as this may cause an electrical fire.
	When power cord or power plug has been damaged or an outlet comes loose, do not use.

	The machine should be placed horizontally in an environment in which there is no danger of dropping or hitting it.
	The machine should be installed away from direct sunlight or heaters such as a fire place or electric heater.
	Don't use hot water (over 104 degrees Fahrenheit), as it may cause damage.
	Don't put objects on top of the machine, as it may cause damage.
	Make sure the machine is correctly attached to the wall if you choose this method of mounting the machine.



Please read this thoroughly for your safety.

	If the machine has not been used for several days, run water through the machine for 1-3 minutes before starting the machine.
	Users who are not familiar with this water are recommended to start with alkaline water level 2 and adjust quantity/level of water to suit your needs. Generally alkaline water at level 2-3 is recommended but it depends upon your health conditions.
	Store alkaline water in an air tight container and put it in a refrigerator for up to 2 days.
	Do NOT drink: 1. Acid Water
	Don't fill the fish bowl with this water, as it can kill the fish.



Please read this thoroughly for your safety.



Definition of ionized water

	<p>Don't use containers such as aluminum or brass, as they can be tarnished by this water. Contact your distributor if water smells bad, as you may need extra filtration or your source water may be contaminated.</p>
	<p>Please observe the following cautions when handling the reagent drops.</p> <ol style="list-style-type: none"> 1. Do not put it into eyes. If this happens, wash your eyes out and consult with doctor. 2. Do not drink and if you do, then drink lots of water to flush out your system 3. Store it in an airtight container away from children. 4. Keep away from fire, as it is flammable.
	<p>Don't use water spray to clean the machine.</p> <p>Don't block the vent or insert items in the vent, as it can cause an electrical short.</p> <p>Don't block the water passage, as it can cause water leakage or malfunction.</p> <p>Don't use benzene, thinner, or chemicals to clean it as it can damage the machine.</p>
	<p>Instructions – when you are to be away for more than several days.</p> <ol style="list-style-type: none"> 1. Unplug the power plug. 2. Turn off the water valve as it can cause a water leak.

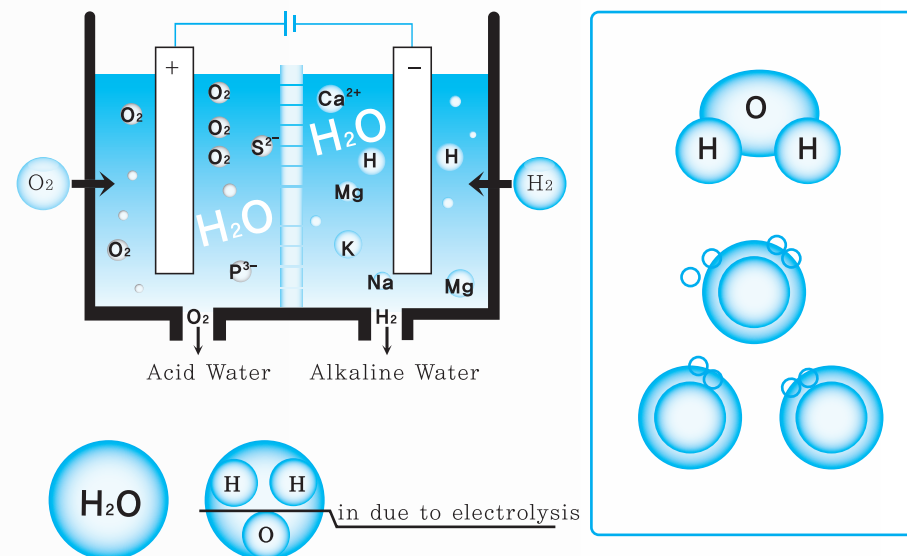

With electrolyzed water, the cathode (-) produces alkaline ionized water with minerals (pH scope 7.5~10) – such as Ca, K, Mg, Na, etc. because of the hydroxyl ion (OH⁻) generating reaction. The anode (+) has lots of hydrogen (H⁺) (pH scope 3.5~6.5) because the oxygen gas (O₂) generates a reaction and acid ion water has many ions such as Cl, S, P. The alkaline ion water and acid ion water made by an electrolytic reduction water generator, has characteristics like those below.

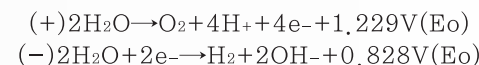

The level of acidity (pH) is marked from 1 to 14. Alkaline has a pH of more than seven and acid has a PH of less than seven.

$$\text{pH} = -\log[\text{H}^+]$$



Properties of Ionized Water

When water is applied with DC current through platinum coated titanium anode and cathode, the anions in the water is attracted and collected at the anode producing acid ion water, and the cations are attracted and collected near the cathode producing alkaline water.

Acidic water, that has an astringent effect, is cosmetically good for you because it causes the pores to contract and protects your skin. Alkaline ionized water contains alkaline minerals, which are good for your health. You can absorb minerals better from the micro-clustered water as there are less molecules per cluster, so you have better hydration and detoxification.

Ionized water can also be substituted for chemicals such as sanitizers, cleaners. In addition, it contributes to reducing pollutants, protecting water and air pollution and alleviating the health/environment problem in general.



Installation of parts guide

Parts

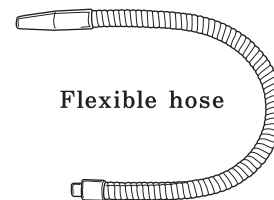

Flexible hose

Fuse



BTB chemical



Wall-mount nail



Tubing hose

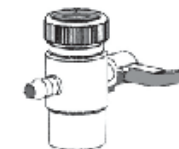

Diverter



User manual

Installation guide

1. Check the following before installing the machine
 - Set up the Ionizer laying it horizontally and on a flat surface
 - Such an environment should be avoided for the ionizer:
 - 1) Near fire or a source of heat (above 60°C)
 - 2) Humid and dusty area
 - 3) Near water
 - 4) Where it is exposed to the direct rays of sunlight or near any kind of heaters
 - 5) Behind the refrigerator or microwave which is generally a source of fire (main body and hose piping is prohibited)
 - When the machine is to be mounted to the wall
 - 1) Attach the proper wall-padding which is for domestic wall-mounting to the spot where the machine is to be attached
 - 2) Make a hole at the position of the wall mounting bolt and fasten the bolt
 - 3) Install the mounting device on the rear of the main body on the bolt

! Operation Warnings

Operation Warnings

DO NOT use the ionizer with the following water as it can cause a breakdown of the machine!

1. Dirty water
2. Salt - water
3. Water with high amounts of iron or rust
4. Water Above 40°C/104°F



Read the instruction thoroughly before any operation

Parts for the Ionizer (front)

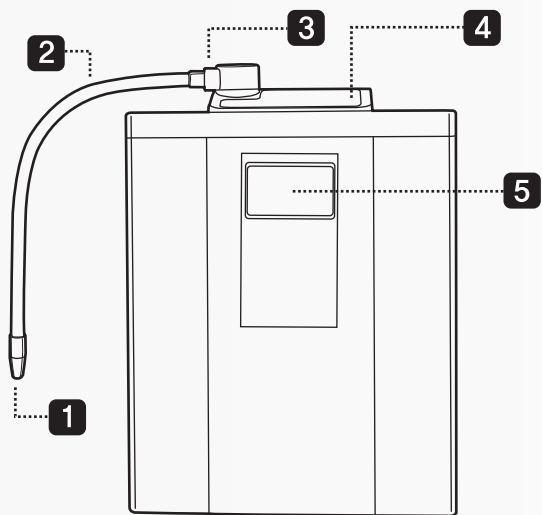

1. Water passage
2. Treated water hose
3. Flexible hose connector
4. Operator
5. LCD Panel

Parts for the Ionizer (back)

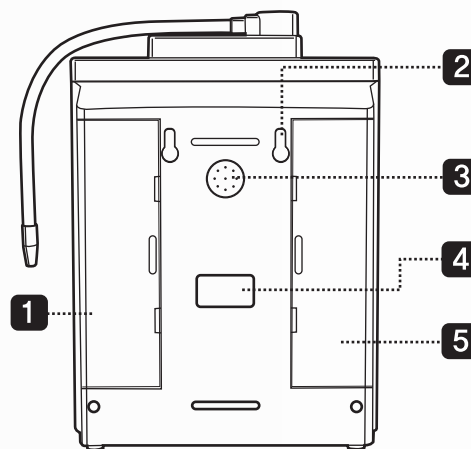

1. Primary Filter Cover
2. Wall_Mount
3. Speaker
4. Product Specification Label
5. Second Filter Cover

Parts for the Ionizer (back)

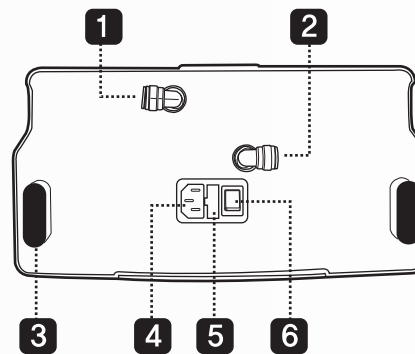

1. Water Outlet
2. Water Inlet
3. Base
4. Power Connector
5. Voltage and Fuse
6. Power ON/OFF Switch

! Operation Method

Display Window	Operation Method	Description
		When Alkaline water is chosen Levels 1~4 can be selected
		When purified water is selected, pH is not indicated
		When acidic water is selected, Level 1~2 can be selected.
		When function selected, FN 0~4 (volume control) can be selected.
		When the filter button is selected, the replaced Filter 1 or Filter 2 is reset, and the filter indicator displays 0000
		When function selected, FN 0~4 (amperage control) can be selected.
		When FN is selected, the Filter 1 or 2 button is used to adjust volume and amperage levels.

! Indicator Functions

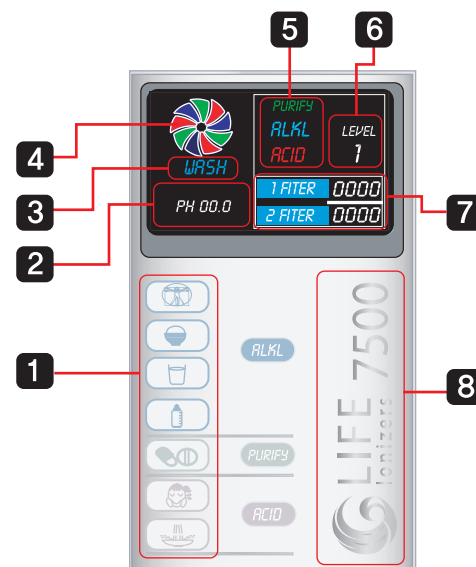

1. Drinking method indicator
2. pH
3. Indicates 'Being Washed'
4. Rotates while cleaning
5. Indicates ion water type (alkaline, acidic, purified)
6. Indicates selected ionization water setting
7. Filter life-indicator
8. LIFE Ionizer Logo

Voice Functions

Water Cleaning Button

*It is being washed now. Please wait a minute

Alkaline Water Button

- *Alkaline 4-step is being extracted
- *Alkaline 3-step is being extracted
- *Alkaline 2-step is being extracted
- *Alkaline 1-step is being extracted

Acid Water Button

- *Acidic water 2-step is being extracted
- *Acidic water 1-step is being extracted

Purified Water Button

* Purified water is being extracted.



Installation guide

Please see the attached Diagram

Assembly method of valve for Deck-sink water taps

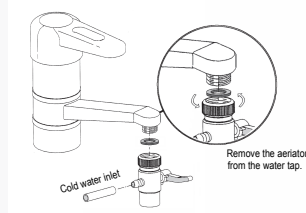

Assembly method of valve for Deck-sink water taps

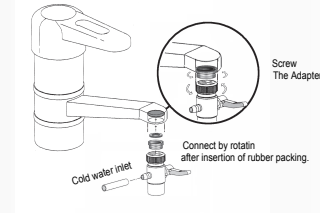

Assembly method of valve for wall-mounted water taps

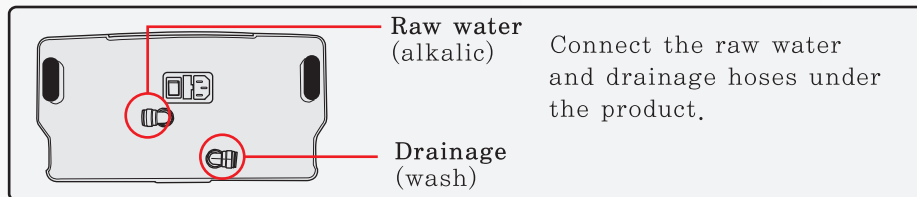
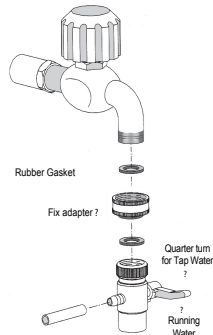

Installation instructions for Life Ionizer 7500

“Use Cold Water Only With Your Life Ionizer”

Please note-The DVD contained in the box with your Life Ionizer is for general education purposes. The instructions to install your specific model are below and **not on the DVD.**

Step 1- Unscrew the existing aerator from your faucet

Step 2- Screw the Life Ionizer diverter valve onto your faucet. Three different sized adaptors are included for non-standard sized faucets

Step 3- Unscrew the round nut from the side of the diverter valve. Slide the nut over the end of the 1/4” tubing and then screw the nut back onto the diverter valve. Tubing should now fit snugly onto the diverter valve

Step 4- Remove plugs from the inlet and outlet valves at the bottom of the unit. ***Note- To remove the plugs you must push down on the ring at the end of the valve and then pull the plug out (use a butter knife).

***Note- Some units may contain water don't be alarmed! We test units to make sure they are in working condition.





Installation tip

1. Install and set up the machine laying it horizontal and in a flat and safe area
2. Make sure the machine is not connected to hot water

* This machine must be installed following all instructions. The manufacturer is not responsible for any problems caused by not following all instructions.

! Production of Ionized Water

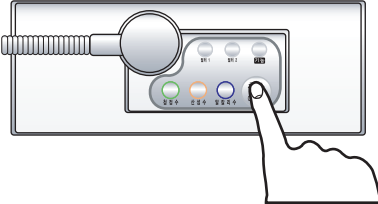
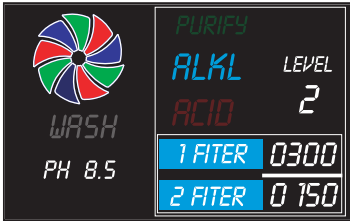
📖 Alkaline and Acidic Water Usage Guide

	<ol style="list-style-type: none"> 1. Press the main water flow button on top of the product. 2. Select the water type – Alkaline, Acidic, or Purified setting
	<ol style="list-style-type: none"> 3. When the 'alkaline' is selected, the LCD indicates the alkaline setting and level
	<ol style="list-style-type: none"> 4. According to the selected step, the LED indicates the pH of the water

⚠ Notice (Fig. 1)

When you select the main water flow button while the water pressure is low or valve is closed, the LCD will appear as "Fig. 1" Please check the water pressure or valve opening before proceeding



Alkaline Water Usage Guide

- 1) If the machine has not been used for several days, let the water run on the "Purified Water" setting for at least 3–5 minutes before any operation
- 2) Users who are not familiar with this water are recommended to start with alkaline water level 2 and adjust the quantity/level of water which might fit you the best. Increase slowly over time as your body adjusts
 - *Level 2–3 is recommended for first time alkaline ionized water drinkers
- 3) Store alkaline water in an airtight glass container and put it in a refrigerator for no longer than 2 day for maximum benefit
 - *First 12 hours after ionization the water is most effective

Acidic Water Usage Guide

- Such water is not drinkable– DO NOT DRINK
- 1) Use acid water only for disinfecting, cleaning, plants and as a face/skin toner
 - 2) Acidic water properties are the best 1–7 days after ionization if it is put in an airtight glass container and kept in the refrigerator.

Purified Water Usage Guide

- 1) Clean water is chlorine-free due to the internal Ionizer filters and ionizer pre-filter(s)
- 2) It is best to drink purified water when taking medicines and pills

! Internal Filter Replacement

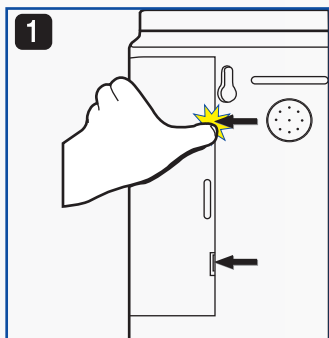

1. Press the top and bottom of the filter cover.

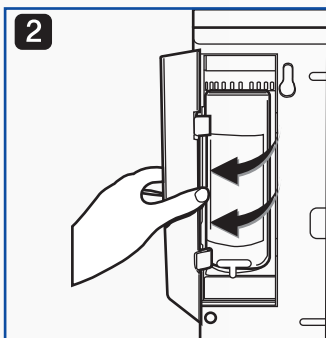

2. Open the filter cover following the direction of the arrow

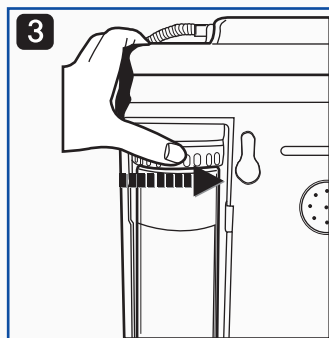

3. Turn the filter top in the arrow direction.

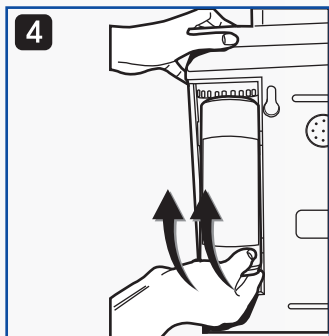

4. Lift the filter up and out following the direction of the arrow

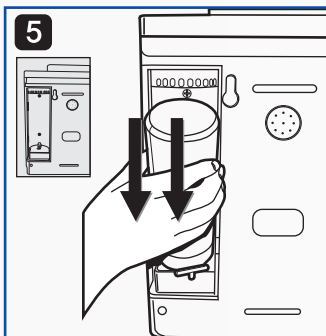

5. Insert the new filter following the direction of the installation arrow and turn the filter base appropriately

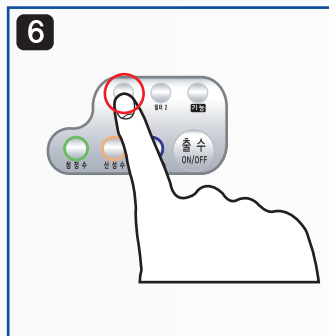

6. Reset the new filter button on the ionizer

Tips After Filter Replacement:

1) Select the "Purified Water" setting and let the water run for 3-5 minutes after any filter replacement
 2) If the machine has not been used for a few days, let the water run for 3-5 minutes at the "Purified Water" setting before making alkaline ionized water for consumption
 3) Consult with the installer or retailer on the purchase of filter if in question about usage or installation

! Filter



First Filter: Filter A

- Special sediment:** A pre-treatment filter that eliminates ordinary sediments (mud, dust, rust, sand, dreg, etc) in the body with 10 μ m(1/100mm) stirring movement.
- Pre-carbon:** Absorbs and eliminates various harmful chemical compounds, remaining chlorine, THM, etc., within the water
- Silver-coated activated carbon:** Using 20~40 mesh of ultra-fine natural coconut providing excellent performance and elimination of chemical compounds and chlorines, restraint of bacterial breeding and revitalization of the water's taste and fragrance into the most ideal water to drink.
- Special sediment:** Prevent outflow of filtration remnants after the filtration, and eliminate remaining sediments.

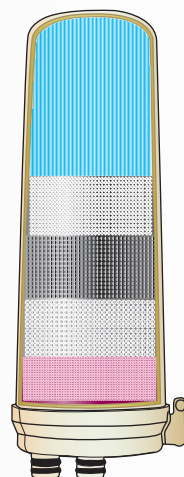

Second Filter: Filter B

- Granule type concentrated carbon:** Eliminates remaining chlorine - excellent and fast absorbing of harmful materials with chemical compounds, generates low level of dust, and is lightweight.
- Pi-ceramic:** Generates natural negative ion type surface active materials - making water molecular groups (clusters) smaller for faster absorption and quicker hydration.
- Bio ball-ceramic:** High quality ceramic that absorbs/eliminates various bacteria, colon bacillus, and viral compounds of calcium.
- Calcium Sulphite T mineralization:** "Generates smooth alkaline ion water, which may aid in healing chronicle diarrhea, aepsia, abnormal fermentation in stomach, normalization of the body's cells, etc.
- Special sediment:** Prevents outflow of filtration remnants after filtration and eliminates remaining sediments

Uses of Alkaline Ionized Water

Highly Alkaline Water – pH 11.0+

Highly Alkaline Water preserves hygiene in your daily life due to its strong cleaning effect. It has absorbing, dissolving and heat conducting benefits.

Food Preparation: Remove rawness from vegetables such as green onions, bamboo, wasabi and flowering fern with high pH water.

Cleaning: Clean cutting boards and dishcloths. Good for cleaning oil and tough grime from vents, as well as for general cleaning in the kitchen.

Stain Removal: The extra strength, absorption power will remove coffee, soy sauce and oil stain with ease. Also great for getting out stubborn toilet bowl stains.

Dishes: Use less detergent when washing dishes. Save on water bills, as only one-third to one-fourth of the usual amount of water is adequate for rinsing of detergent.

pH Water – 8.0 – 10.0

Absorbing, dissolving and heat conducting benefits.

Drinking: Drink 2–3 cups of water first thing in the morning. Compared to tap water, Alkaline water has no unpleasant odor, tastes lighter, and has a pleasantly sweet flavor. It is important to include vegetables in your diet, when eating substantial amounts of acidic food such as egg yolk, white rice, chicken, pork and beef. Drinking alkaline water is equally important because it balances the acidic and alkaline effects of these foods.

Food Preparation: Clean vegetables and fish. Enhance the flavor of broccoli, onions, bamboo etc. by pre-boiling them in alkaline water. Use less condiments and salt.

Rice: Use alkaline water for washing and cooking rice. The result is delicious and fluffy rice.

Coffee and Tea: For which taste and aroma are everything, you will be surprised at the improved color, taste, and aroma. And you can use less coffee or tea and still achieve a full rich taste due to the water's extractable ability.

Soups and Stews: Alkaline water draws out the flavor of ingredients so they get tender and juicy. Therefore, less seasoning such as salt and soy sauce are needed, so this water is good for people that want to reduce their salt intake.

Plants: Use to water plants and flowers. Alkaline water extends the freshness and life of plants. Alkaline water with a pH-level 9.0 can also restore the health of sick plants. Alkaline water stimulates germination and improves seeding development.

Animals: Your animals' health will improve dramatically. Unpleasant body odor will decrease, as well as the odor of feces and urine.

Crafts: Excellent for dyeing cloths, as well as other craft projects. You will love the vibrant colors obtained when using this water.

Health: Through continuous use, the acidic tendency of your body can be gradually corrected to an alkaline constitution. Drink at least 2 liters a day in order to gradually change an acidic constitution to a slightly alkaline one.

Calcium: Continued use will replenish your calcium levels. Helps to reduce irritability, and improves the general health of children.

Colon cleansing: Warm the water to body temperature and use colon cleansing unit to remove accumulated debris and waste.

Other uses: One theory is that this water reduces free radicals. Recently, this water has been acclaimed as "Free Radical Water". It slows down aging and stabilizes body temperature.

pH Water – 7.0

Free of chlorine, rust and cloudiness. Clean water is delicious drinking water.

Children: Use Clean water pH 7.0 when preparing baby food.

Uses of Acidic Ionized Water

pH Water – 4.0 – 6.0

Not safe for drinking! Recognized for its astringent effects.

Face wash: The astringent properties of Acidic water are effective in toning and firming your skin. Pat the skin and leave to dry. This water is also excellent as a toner after shaving.

Hair Care: Use this water instead of rinse after shampooing. Reduces annoying tangles and brings out a radiant shine. Keep in a spray bottle and spray your hair and face when you're out and about.

Bath water: Add Acidic water to your bath to keep your tub free of bathtub rings. Bathing in this water gives your body a warm and comfortable feeling.

Pet Care: Spray your pet with this water and brush afterwards to obtain soft and shiny fur. Great for grooming your pet!

Rinse cycle: Soaking in Acidic water before the spin cycle will soften your clothes.

Cooking beans: Various types of beans, such as kidney beans and green peas, will cook to perfection. Just be careful not to overcook your beans. Acidic water will speed up the cooking time! This is energy saving water!

Washing vegetables and fruits: Keep the vivid colors of strawberries, red cabbage, asparagus and eggplants. And remember, this water is free of chlorine!

Fried food: Fried food comes out nice and crispy

Frozen food: Spray foods with Acidic water when freezing so that the food, including fish and shrimp, do not lose its flavor when thawed out.

Stains: To remove stains, grime and grease, leave to soak in water for 24 hours.

Dishes: Dishes and glasses come out sparkling clean.

Polishing: Polish mirrors, eyeglasses, glass objects and windows to a high sheen.

Housecleaning: Remove dirt from hardwood floors, ceramic tiles etc., without leaving a sticky residue.

pH Water – 2.7 and below

Not safe for drinking! Disinfecting and antibacterial effects.

Acidic water has a remarkably strong disinfecting power. Because hygienic's are performed with water, there is nothing safer than this. Acidic water is the strongest disinfecting power of its kind; it kills all known germs and bacteria on contact.

Cleaning and disinfecting: Sanitize knives, cutting boards, dish towels, and kitchen cloths, etc. Clean and disinfect in and around the kitchen, which is a breeding ground for germs. For a more powerful disinfecting effect, clean with high pH water before using low pH acidic water. Because of strong acidity, metal that rusts easily should be wiped with a dry cloth.

Hygien: Disinfect your hands, your toothbrush or use the water to brush your teeth with or as mouth wash. Keep a spray bottle in your bathroom for easy access.

Low pH Acidic water was approved for disinfecting food products in June 2002, in accordance with Food Hygiene Law, under the name hypochlorous acid water. It is now used for a wide range of applications, including the cleaning and disinfecting of foods and cooking facilities.

Beauty salons, hair salons, restaurants, agricultural colleges, daycare centers, pet shops and nursing homes all benefit greatly from low pH Acidic water.



Common Problems and Solutions

Common Problems and Solutions

Check the following before requesting A/S.

An overhaul of the machine should be operated only by authorized personnel.

Condition	Possible Problem	Solutions
The power light is not on.	Check if the power plug and outlet is plugged correctly	Plug in correctly
The switch does not seem to work	<ul style="list-style-type: none"> · Check to see if the power plug and outlet are plugged-in correctly and/or · Check if the fuse on the back is connected 	<ul style="list-style-type: none"> · Insert plug correctly and /or · Check the fuse and if it does not seem to be working properly, refer to fuse replacement Item19
Water doesn't come out or production volume is changed, or changed to filtering, or the machine suddenly stops working	<ul style="list-style-type: none"> · Check if the valve for hot water is turned off · Check if the water hose is connected, · Check if the hose is folded, · Check if the water pressure is too low · Check if the hose is frozen or disconnected · Check if the filter isn't blocked 	<ul style="list-style-type: none"> · Turn on the valve, · Connect the hose correctly, · Stop the operation, · Wait until the water comes out, · Replace the filter, · After spotting water leakage from ion water machine, turn off the water valve and contact the customer service center
Hose is leaking at the joint	Is the hose joint lose?	Connect the hose correctly
The concentration of alkaline water is too low	<ul style="list-style-type: none"> · Check if the concentration of alkali water is set to a low setting · Check if the water is not overflowing, 	Connect the hose correctly

Condition	Possible Problem	Solutions
Water has a distinct odor and taste	<ul style="list-style-type: none"> · Check the most recent date of usage – may need to replace filters if ionizer is sitting more than 2 weeks 	<ul style="list-style-type: none"> · Let the water run through the ionizer for more than 3 minutes. If the problem still exists, replace the filters
Filter replacement warning lamp is still on even after replacement,	Check if the filter has been reset,	<ul style="list-style-type: none"> · Reset the filter button on the ionizer
Machine makes a strange sound.		<ul style="list-style-type: none"> · Stop operation and contact the customer service center
It suddenly stops producing alkali/acid water and power is turned off.	Check if the water source rate too small or suddenly off	<ul style="list-style-type: none"> · Open the water valve or replace the filter,



Instructions for Installing Pre-Filter



Contact Us



1. Step One: Cut the tubing going to your ionizer at the desired location
2. Step Two: The cap on top of the filter housing is marked "IN" and "OUT"



3. Step Three: The tubing coming from the cold-water connector needs to be inserted into the side of the housing marked "IN". Firmly press the tubing into the filter-housing cap. You will feel the tubing stop when it is fully inserted. Pull on the tubing gently to ensure that it does not come out and a good connection was made. If possible, flush the filter by turning on the flow of water slowly and point the "OUT" towards the sink. Let it run for 2-3 minutes and turn the water flow off.



4. Step Four: Insert the tube going to the ionizer into the side of the housing marked "OUT" by firmly pressing the tube into the filter-housing cap.
5. To remove the tubing from the filter cap, press in on the O-ring and tubing simultaneously, then gently pull out on the tubing



Address:

2335 Camino Vida Roble, Bldg B
Carlsbad, CA 92011

Phone:

888-688-8887
760-431-8047

Website:

www.Lifelionizers.com